

S2M0160120K

1200V SiC POWER MOSFET

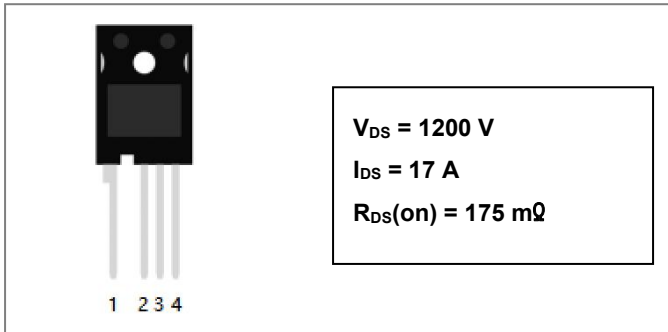

Description

S2M0160120K is single SiC Power MOSFET packaged in TO-247-4 case. The device is a high voltage n-channel enhancement mode MOSFET that has very low total conduction losses and very stable switching characteristics over temperature extremes. The S2M0160120K is ideal for energy sensitive, high frequency applications in challenging environments.

Circuit Diagram

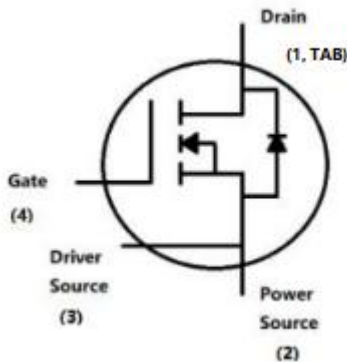

Features

- Positive temperature characteristics, easy to parallel.
- Low on-resistance Typ. $R_{DS(on)} = 175\text{m}\Omega$.
- Fast switching speed and low switching losses.
- Very fast and robust intrinsic body diode.
- Process of non-bright Tin electroplatin

Applications

- EV Fast Charging Modules
- EV On Board Chargers
- Solar Inverters
- Online UPS/Industrial UPS
- SMPS (Switch Mode Power Supplies)
- DC-DC Converters
- ESS (Energy Storage Systems)

Maximum Ratings(T=25°C unless otherwise specified)

Characteristics	Symbol	Condition	Max.	Units
Drain Source Voltage	V_{DSS}	$V_{GS} = 0\text{V}, I_{DS} = 100\mu\text{A}, T_C = 25^\circ\text{C}$	1200	V
Gate Source Voltage	V_{GSS}	$T_C = 25^\circ\text{C}$, Absolute maximum values, AC ($f > 1\text{Hz}$)	-10 to +25	V
Gate Source Voltage	V_{GSOP}	$T_C = 25^\circ\text{C}$ Recommended Operational Values	-5 to +20	V
Continuous Drain Current	I_D	$V_{GS} = 20\text{V}, T_C = 25^\circ\text{C}$	17	A
	I_D	$V_{GS} = 20\text{V}, T_C = 100^\circ\text{C}$	12	A
Pulsed Drain Current	$I_{D,pulse}$	$T_C = 25^\circ\text{C}$	40	A
Power Dissipation	P_D	$T_C = 25^\circ\text{C}$	130	W

Electrical Characteristics(T=25°C unless otherwise specified)

Characteristics	Symbol	Condition	Min.	Typ.	Max.	Units
Drain Source Breakdown Voltage	$V_{(BR)DSS}$	$V_{GS} = 0\text{ V}, I_D = 100\text{ }\mu\text{A}$	1200			V
Gate Threshold Voltage	$V_{GS(th)}$	$V_{DS} = V_{GS}, I_D = 2.5\text{ mA}$	2.0	2.8	4	V
		$V_{DS} = V_{GS}, I_D = 2.5\text{ mA}, T_J = 175\text{ }^\circ\text{C}$		1.9		V
Zero Gate Voltage Drain Current	I_{DSS}	$V_{DS} = 1200\text{ V}, V_{GS} = 0\text{ V}$		1	100	μA
Gate Source Leakage Current	I_{GSS}	$V_{GS} = 20\text{ V}, V_{DS} = 0\text{ V}$			250	nA
Drain Source On-State Resistance	$R_{DS(on)}$	$V_{GS} = 20\text{ V}, I_D = 10\text{ A}$		175	196	m Ω
		$V_{GS} = 20\text{ V}, I_D = 10\text{ A}, T_J = 175\text{ }^\circ\text{C}$		300		m Ω
Transconductance	gfs	$V_{DS} = 20\text{ V}, I_D = 10\text{ A}$		3.3		S
		$V_{DS} = 20\text{ V}, I_D = 10\text{ A}, T_J = 175\text{ }^\circ\text{C}$		3.4		S
Input Capacitance	C_{ISS}	$V_{GS} = 0\text{ V},$ $V_{DS} = 1000\text{ V}$ $V_{AC} = 25\text{ mV}$ $f = 100\text{ kHz}$		513		pF
Output Capacitance	C_{OSS}			35.6		
Reverse Transfer Capacitance	C_{RSS}			2.59		
Coss Stored Energy	E_{OSS}			20.5		
Turn-On Switching Energy	E_{ON}	$V_{DS} = 800\text{ V}, V_{GS} = -5/+20\text{ V}$ $I_D = 10\text{ A}, R_{G(ext)} = 2.5\text{ }\Omega$		90.3		μJ
Turn-Off Switching Energy	E_{OFF}			54.5		
Turn-On Delay Time	$t_{d(on)}$	$V_{DS} = 800\text{ V}, V_{GS} = -5/20\text{ V}$ $I_D = 10\text{ A}, R_{G(ext)} = 2.5\text{ }\Omega, R_L = 80\text{ }\Omega$		3.5		ns
Rise Time	t_r			11.8		
Turn-Off Delay Time	$t_{d(off)}$			7.0		
Fall Time	t_f			13.4		
Internal Gate Resistance	$R_{G(int)}$		$f = 1\text{ MHz}, V_{AC} = 25\text{ mV}, \text{D-S short}$		6.5	
Gate to Source Charge	Q_{gs}	$V_{DS} = 800\text{ V}, V_{GS} = -5/20\text{ V}$ $I_D = 10\text{ A}$		7.7		nC
Gate to Drain Charge	Q_{gd}			8.2		
Total Gate Charge	Q_g			26.5		

Reverse Diode Characteristics:

Characteristics	Symbol	Condition	Typ.	Max.	Units
Diode Forward Voltage	V_{SD}	$V_{GS} = -5\text{ V}, I_{SD} = 5\text{ A}$	3.3		V
	V_{SD}	$V_{GS} = -5\text{ V}, I_{SD} = 5\text{ A}, T_J = 175\text{ }^\circ\text{C}$	2.9		V
Continuous Diode Forward Current	I_S	$V_{GS} = -5\text{ V}, T_C = 25\text{ }^\circ\text{C}$	20		A
Reverse Recovery Time	t_{rr}	$V_{GS} = -5\text{ V}, I_{SD} = 10\text{ A}, T_J = 25\text{ }^\circ\text{C}$ $V_R = 800\text{ V}$	6.6		ns
Reverse Recovery Charge	Q_{rr}		0.04		uC
Peak Reverse Recovery Current	I_{rm}	$diff/dt = 2533\text{ A}/\mu\text{s}$	11		A

Thermal-Mechanical Specifications:

Characteristics	Symbol	Condition	Specification	Units
Junction Temperature	T_J	-	-55 to +175	$^\circ\text{C}$
Storage Temperature	T_{stg}	-	-55 to +175	$^\circ\text{C}$
Typical Thermal Resistance Junction to Case	$R_{\theta JC}$	DC operation	1.15	$^\circ\text{C}/\text{W}$
Maximum Thermal Resistance Junction to Ambient	$R_{\theta JA}$		56	$^\circ\text{C}/\text{W}$

Ordering Information:

Device	Package	Shipping
S2M0160120K	TO-247-4	30pcs/tube

Marking Diagram

Where XXXXX is YYWWL

S2M = Device Type
 0160 = $R_{DS(on)}$
 120 = Reverse Voltage (1200V)
 K = Package
 SSG = SSG
 YY = Year
 WW = Week
 L = Lot Number

Cautions: Molding resin
 Epoxy resin UL:94V-0

Ratings and Characteristics Curves

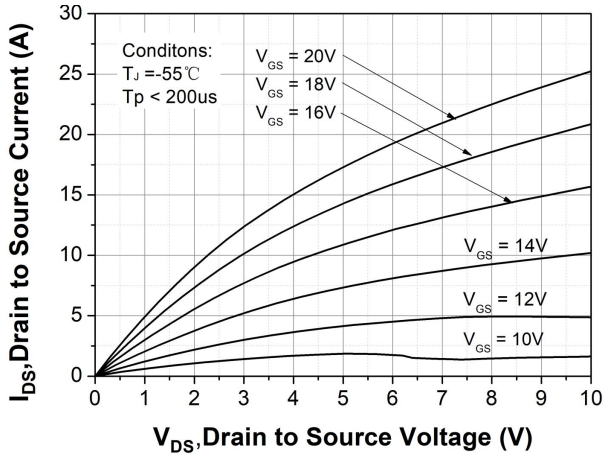

Figure 1. Output Characteristics $T_J = -55^\circ\text{C}$

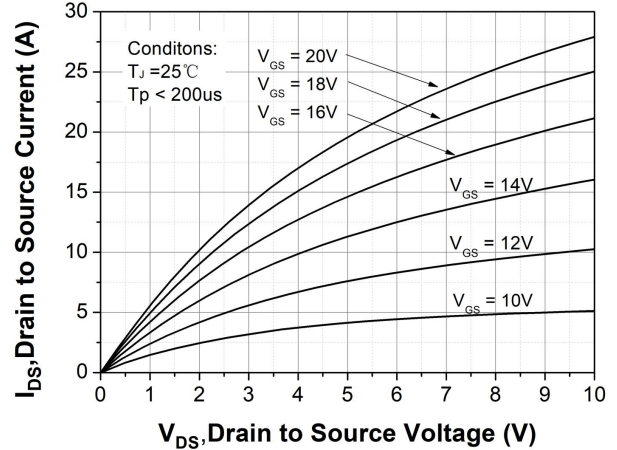

Figure 2. Output Characteristics $T_J = 25^\circ\text{C}$

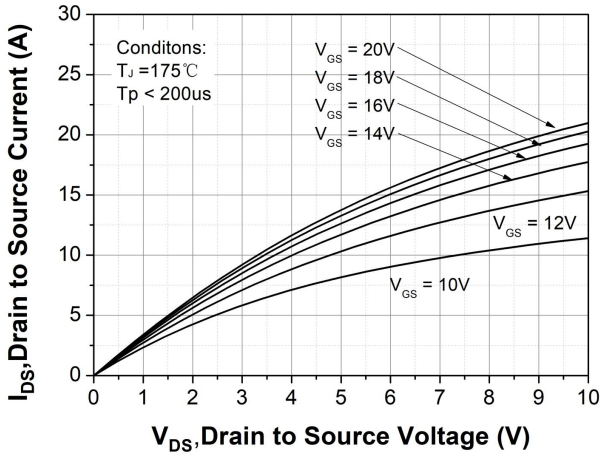

Figure 3. Output Characteristics $T_J = 175^\circ\text{C}$

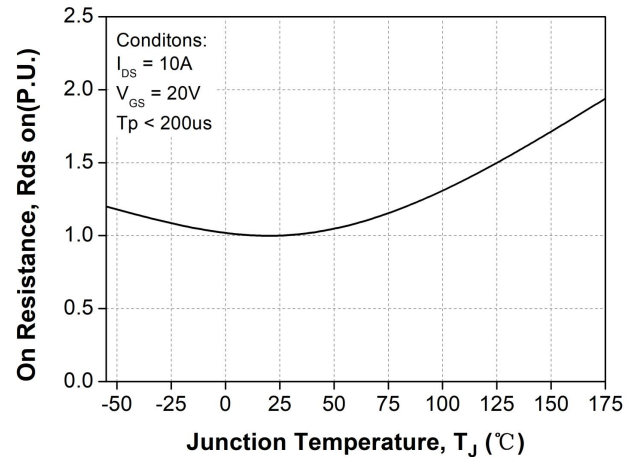

Figure 4. Normalized On-Resistance vs. Temperature

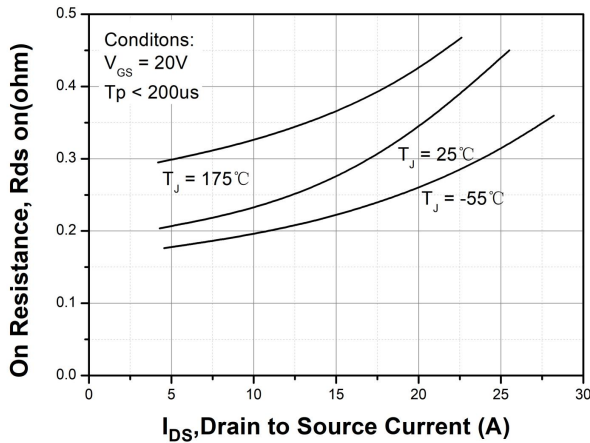

Figure 5. On-Resistance vs. Drain Current For Various Temperatures

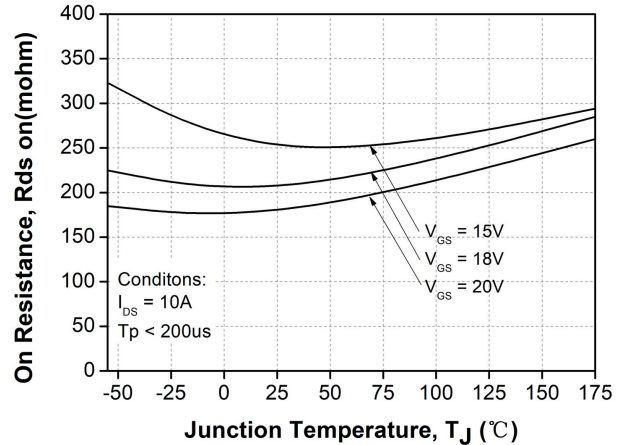

Figure 6. On-Resistance vs. Temperature For Various Gate Voltage

Technical Data
Data Sheet N2717, REV.A

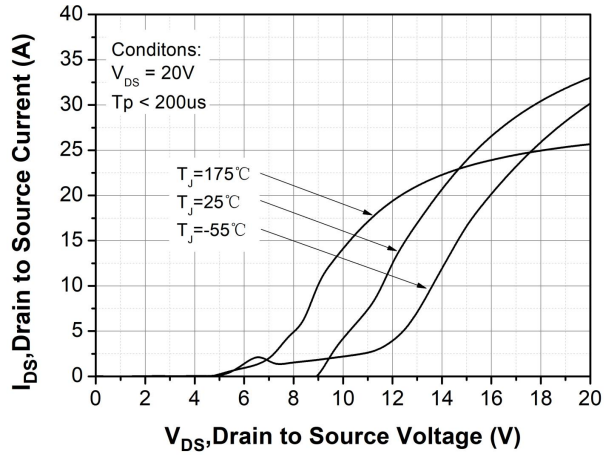

Figure 7. Transfer Characteristic for Various Junction Temperatures

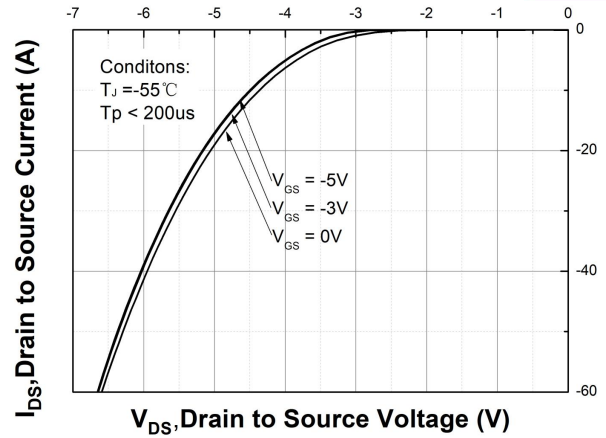

Figure 8. Body Diode Characteristic at $T_j = -55^\circ C$

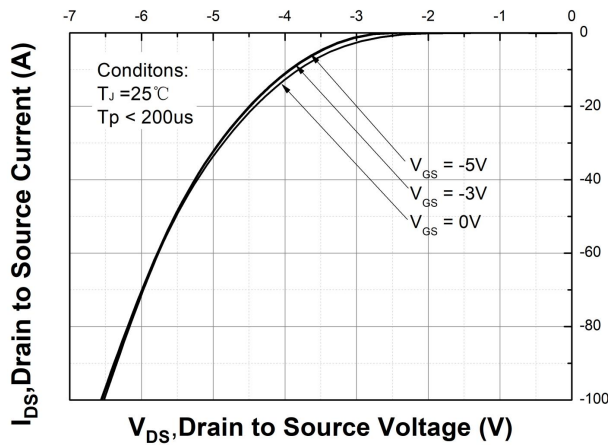

Figure 9. Body Diode Characteristic at $T_j = 25^\circ C$

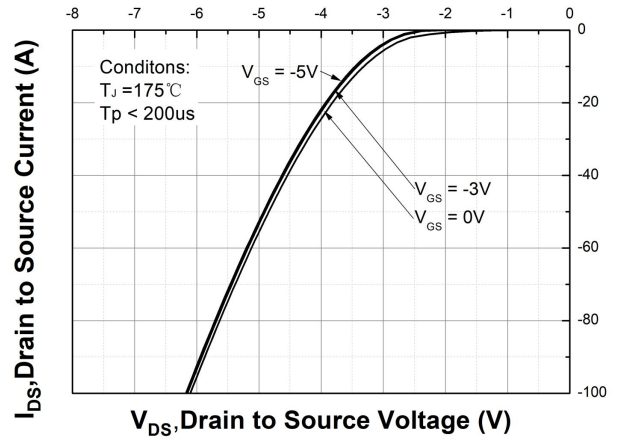

Figure 10. Body Diode Characteristic at $T_j = 175^\circ C$

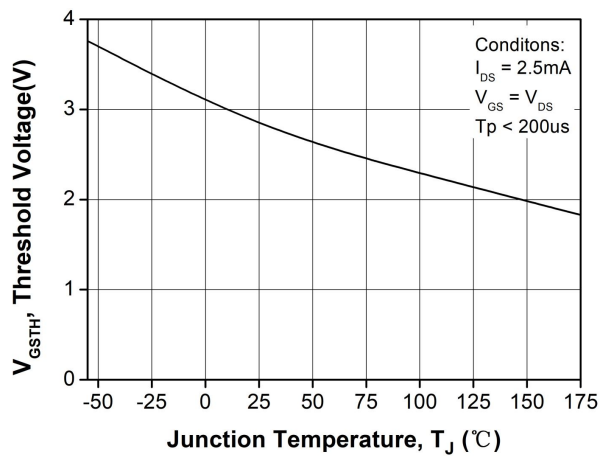

Figure 11. Threshold Voltage vs. Temperature

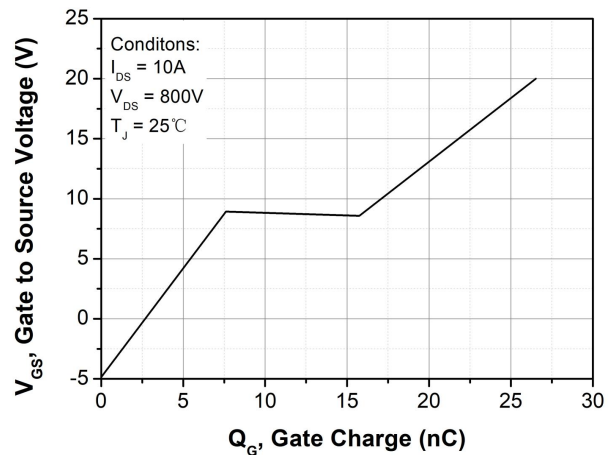

Figure 12. Gate Charge Characteristic

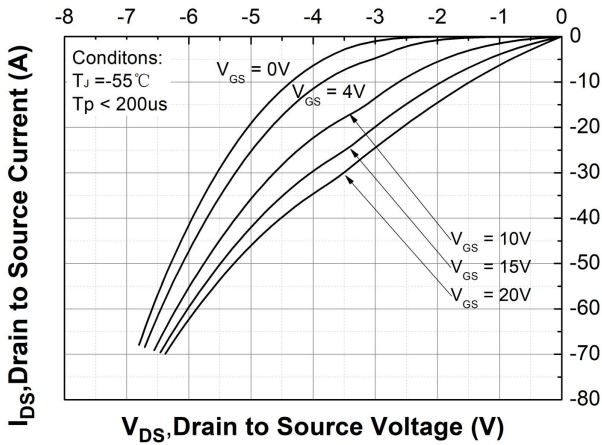

Figure 13. 3rd Quadrant Characteristic at $T_J = -55^\circ\text{C}$

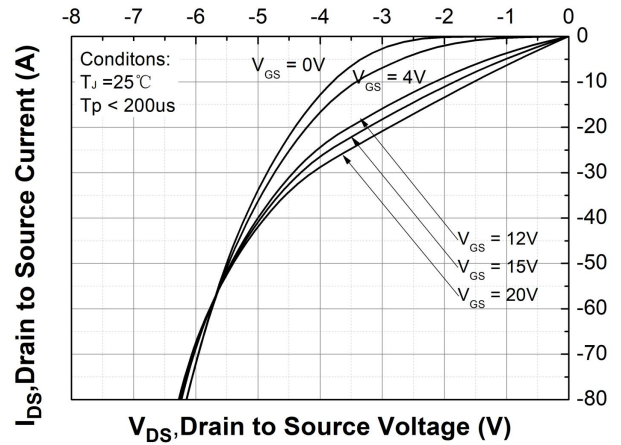

Figure 14. 3rd Quadrant Characteristic at $T_J = 25^\circ\text{C}$

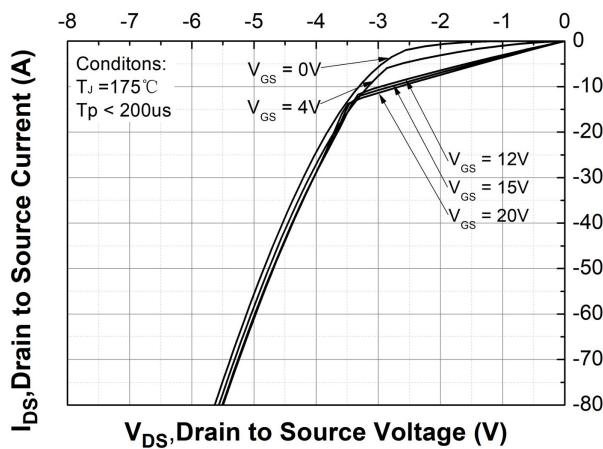

Figure 15. 3rd Quadrant Characteristic at $T_J = 175^\circ\text{C}$

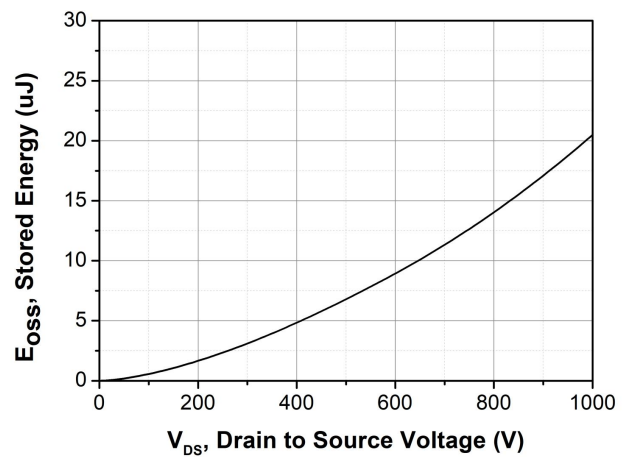

Figure 16. Output Capacitor Stored Energy

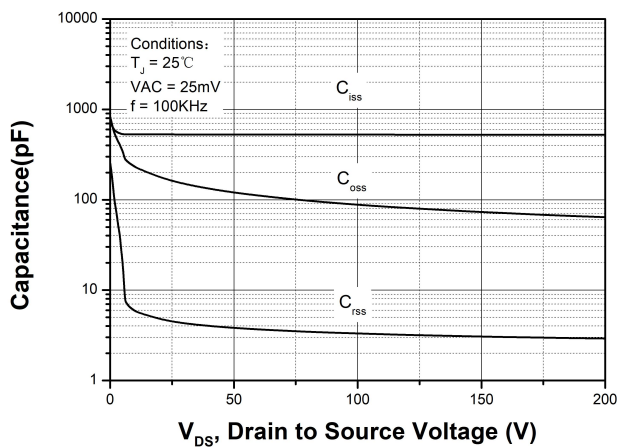

Figure 17. Capacitances vs. Drain-Source Voltage (0 - 200V)

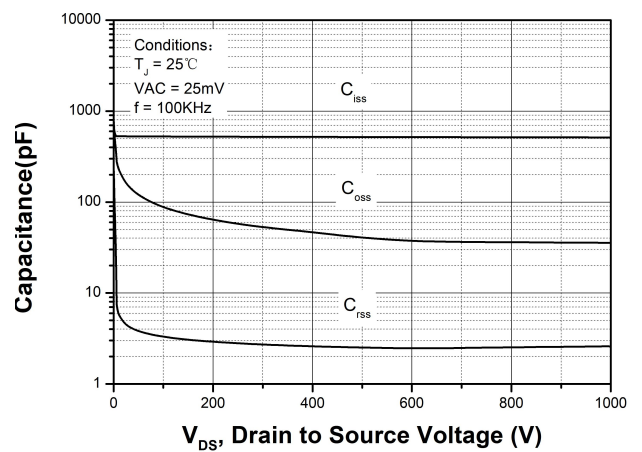

Figure 18. Capacitances vs. Drain-Source Voltage (0 - 1000V)

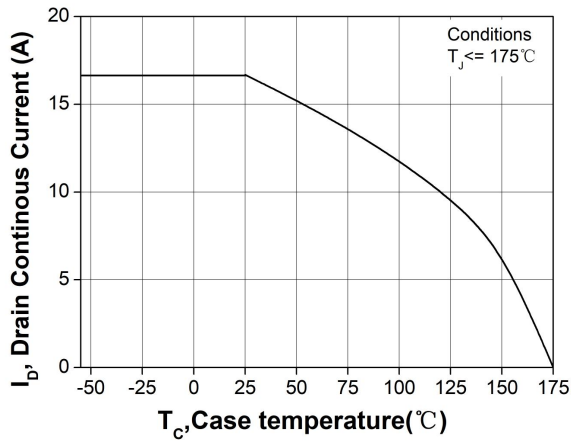

Figure 19. Continuous Drain Current Derating vs. Case Temperature

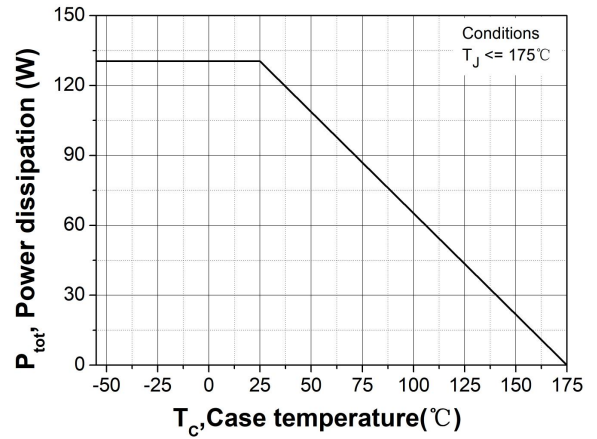

Figure 20. Maximum Power Dissipation Derating vs. Case Temperature

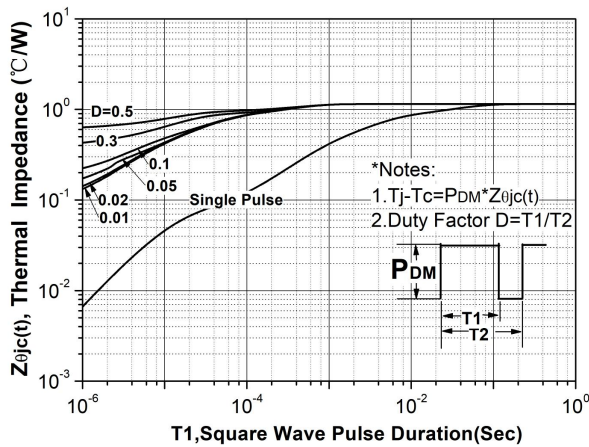

Figure 21. Transient Thermal Impedance (Junction - Case)

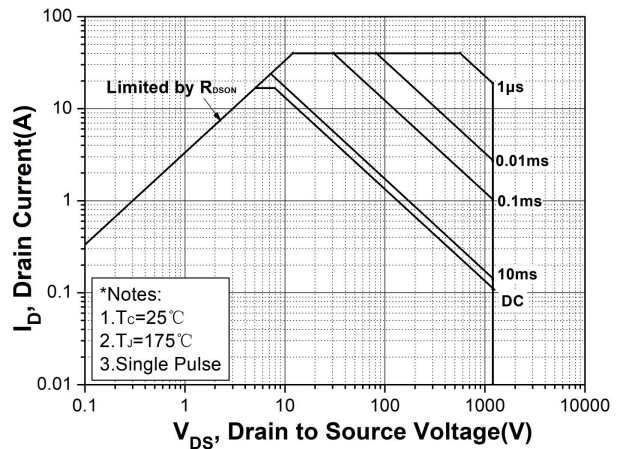

Figure 22. Safe Operating Area

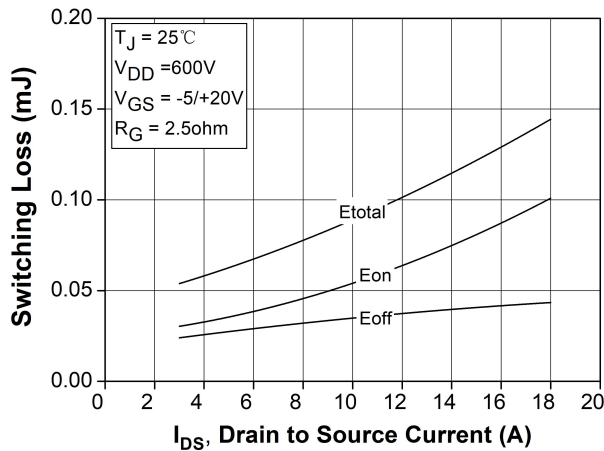

Figure 23. Clamped Inductive Switching Energy vs. Drain Current ($V_{DD} = 600V$)

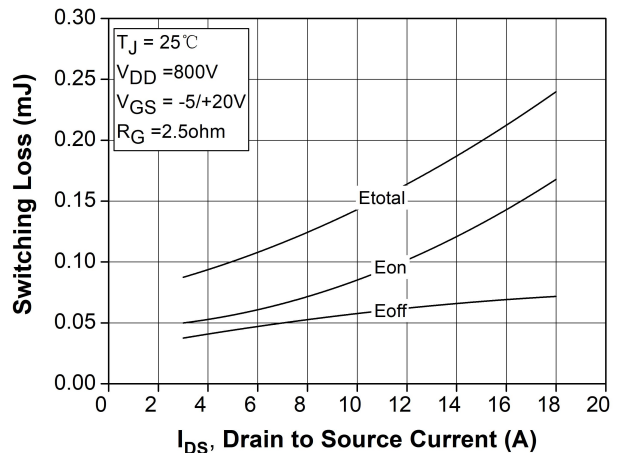

Figure 24. Clamped Inductive Switching Energy vs. Drain Current ($V_{DD} = 800V$)

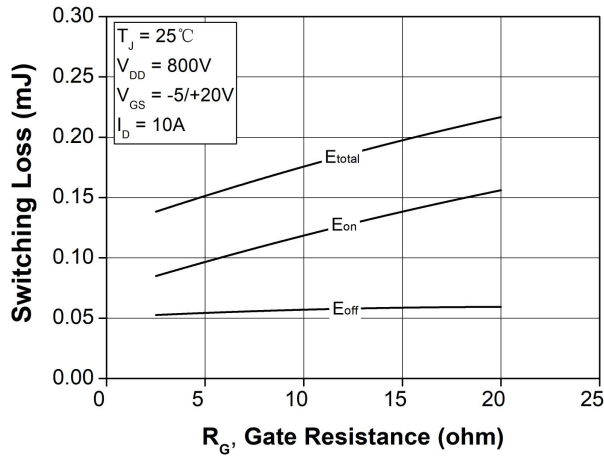

Figure 25. Clamped Inductive Switching Energy vs. $R_{G(ext)}$

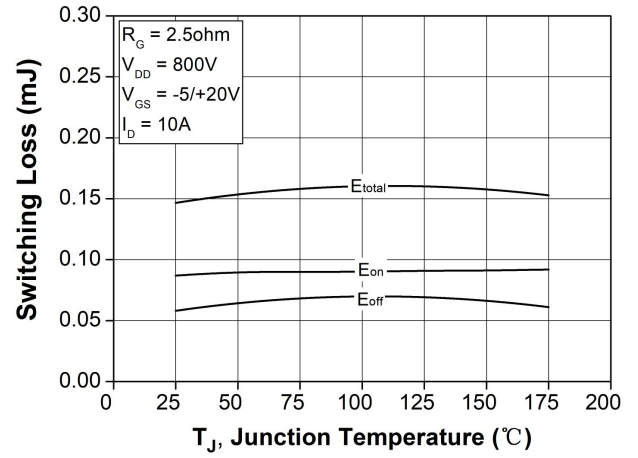

Figure 26. Clamped Inductive Switching Energy vs. Temperature

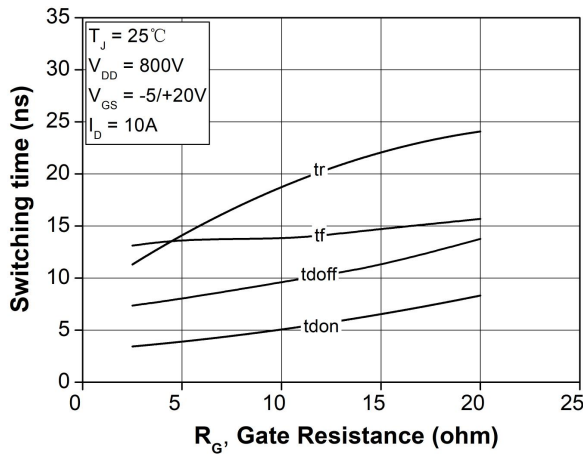

Figure 27. Switching Times vs. $R_{G(ext)}$

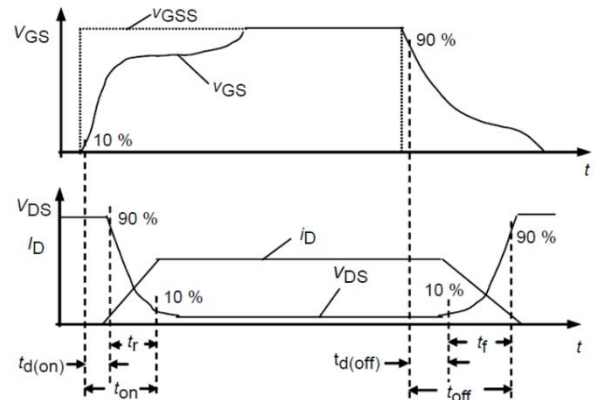
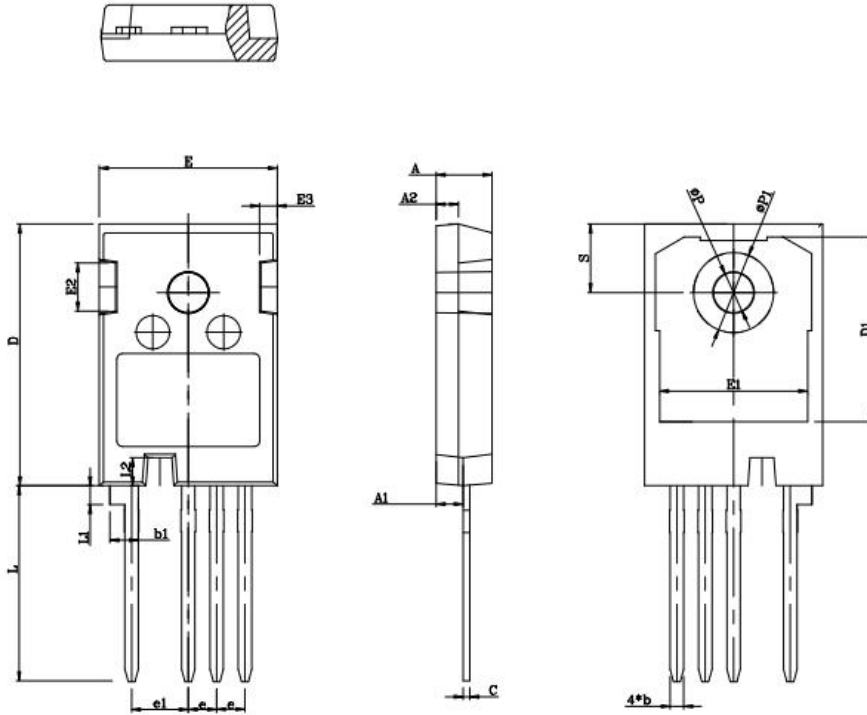

Figure 28. Switching Times Definition

Mechanical Dimensions TO-247-4



SYMBOL	mm		
	Min	Nom	Max
A	4.80	5.00	5.20
A1	2.23	2.41	2.59
A2	1.85	2.00	2.15
b	1.11	1.21	1.36
b1	2.35	2.55	2.75
c	0.51	0.61	0.75
D	23.30	23.45	23.60
D1	16.25	16.55	16.85
E	15.75	15.94	16.10
E1	13.00	13.26	13.43
E2	4.00	4.30	4.60
E3	1.15	1.45	1.75
e		2.54BSC	
e1		5.08BSC	
L	17.31	17.47	17.82
L1	1.50	1.70	1.90
ØP	3.51	3.60	3.65
ØP1	7.08	7.19	7.30
S		6.15BSC	

DISCLAIMER:

- 1- The information given herein, including the specifications and dimensions, is subject to change without prior notice to improve product characteristics. Before ordering, purchasers are advised to contact the SMC Diode Solutions sales department for the latest version of the datasheet(s).
- 2- In cases where extremely high reliability is required (such as use in nuclear power control, aerospace and aviation, traffic equipment, medical equipment, and safety equipment), safety should be ensured by using semiconductor devices that feature assured safety or by means of users' fail-safe precautions or other arrangement.
- 3- In no event shall SMC Diode Solutions be liable for any damages that may result from an accident or any other cause during operation of the user's units according to the datasheet(s). SMC Diode Solution assumes no responsibility for any intellectual property claims or any other problems that may result from applications of information, products or circuits described in the datasheets.
- 4- In no event shall SMC Diode Solutions be liable for any failure in a semiconductor device or any secondary damage resulting from use at a value exceeding the absolute maximum rating.
- 5- No license is granted by the datasheet(s) under any patents or other rights of any third party or SMC Diode Solutions.
- 6- The datasheet(s) may not be reproduced or duplicated, in any form, in whole or part, without the expressed written permission of SMC Diode Solutions.
- 7- The products (technologies) described in the datasheet(s) are not to be provided to any party whose purpose in their application will hinder maintenance of international peace and safety nor are they to be applied to that purpose by their direct purchasers or any third party. When exporting these products (technologies), the necessary procedures are to be taken in accordance with related laws and regulations..